



CTA Timer / Counter / Tachometer Instruction Sheet

Thank you very much for purchasing DELTA CTA series. Please read this instruction sheet before using your CTA series to ensure proper operation and please keep this instruction sheet handy for quick reference.



- **DANGER! Caution! Electric Shock!** When the power is on, DO NOT touch the AC terminals in case an electric shock may occur. Make sure the power is disconnected when you check the unit inside.
- CTA series is an OPEN-TYPE device. They are intended for installation completely within an overall panel and are for use in counting or timing application. If it will cause serious injury to workers or damage on other equipments when used in a dangerous environment, please make sure it is installed in an automatic safety protection device.

■ Precaution

1. Always use recommended solder-less terminals: Fork terminal with isolation (M3 screw, width 7.0mm), hole (diameter 3.2mm). Screw size: M3x6.5 (with 6.8x6.8 square washer). Recommended tightening torque: 0.4 N.m (4kgf.cm). Applicable wire: solid/twisted wire of 2mm², 12AWG to 24 AWG. Please be sure to tighten them properly.
2. Prevent dust or metallic debris from falling into the device and cause malfunctions.
3. DO NOT modify or uninstall the device.
4. DO NOT use empty terminals.
5. Make sure the wires are correctly connected to proper terminals.
6. Keep away from high-voltage and high-frequency environment during installation in case of interference.
7. Prevent using the device in premises which contain:
 - Dust or corrosive gas
 - High humidity
 - High radiation
 - Vibration and shock
8. CTA series is an open-type device. Make sure to install it in an enclosure to prevent dust, humidity in case of an electric shock.
9. Please make sure the power cables and signal device are installed correctly before switching on the power; otherwise serious damage may occur.
10. DO NOT touch the terminals or repair the device when the power is on; otherwise an electric shock may occur.
11. Please wait for one minute after the power is switched off to allow the capacitor to discharge and DO NOT touch the internal wiring within this period.
12. Use dry cloth to clean the device. DO NOT use acid or alkaline liquid to clean the device.

■ Display, Indicators and Keys

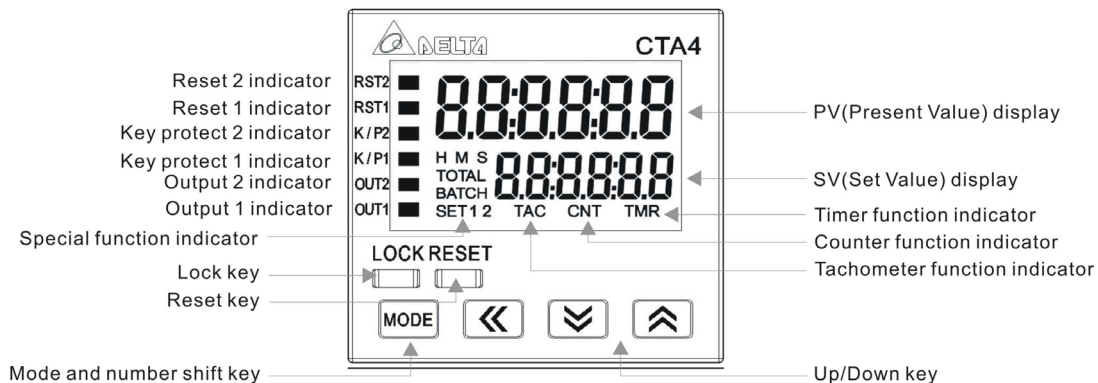

◆ LCD Display & Indicators

RST 1/2	Light on when reset signal is detected	BATCH	"Batch Counting Mode" in Counter and Tachometer function
K/P 1/2	Light on when key-protected mode is enabled	SET 1 2	SV1, SV2 display
OUT 1/2	Light on when output is executing	TAC	Light on when Tachometer function is executing
H M S	Hour, minute, second, unit of timer, displayed in Timer function	CNT	Light on when Counter function is executing

TOTAL	"Total Counting Mode" in Counter and Tachometer function	TMR	Light on when Timer function is executing
-------	--	-----	---

◆ Key Operation

	Increase and decrease SV or change parameter settings.
	Left move 1 digit of the selected digit. The indicator of the selected digit will flash.
	Save the set parameters or switch among functions.
	Prevent settings from being changed. Key-protected mode still works after the power is switched off. Press LOCK to enter key-protected mode. In non-key-protected status, press LOCK to enter Lock 1. In Lock 1, press LOCK again to enter Lock 2. Press and at the same time to disable key-protected mode. LoL1 (Lock 1) disables the functions of all keys. LoL2 (Lock 2) allows users to change SV and functions of RESET remain. LOCK only functions in non-key-protected status.
	Clear and reset PV.

◆ Modes: Operation Mode and Configuration Mode

Operation	When the power is on, the timer/counter/tachometer is in the operation mode. Press to change SV, or to make change on a desired digit. The indicator of the selected digit will flash. After the change is made, press to save the setting. If SV or parameters are not changed, press once to switch between SET1 and SET2.
Configuration	Press in operation mode for more than 3 seconds to enter configuration mode. Press once to switch among parameters. To return to operation mode, press for more than 3 seconds.

■ Ordering Information



1 Product name	CTA: Delta Counter/Timer/Tachometer A series	4 Preset stage	0: 2 preset stage
2 Panel size	4: 48mm x 48mm 1/16DIN	5 Communication	0: none; 1: RS-485
3 Output 2	0: NPN; 1: Relay	6 Power supply	A: AC 100 ~ 240V; D: DC 21.6 ~ 26.4V

■ Specification

Model name	CTA4000A series	CTA4000D series
Power input	AC 100 ~ 240V, 50/60Hz	DC 24V
Input voltage range	85 ~ 110%, rated voltage	DC 21.6 ~26.4V
Power consumption	Less than 10VA	Less than 5W
External power supply	12V DC ±10%, 100mA	
Display	Double-line, 6-digit negative transmissive LCD display	
Input signal	Non-voltage input (NPN): ON impedance 1K ohm max. ON residual voltage: 2V max.	
	Voltage input (PNP): High level: 4.5 to 30V DC, Low level: 0 to 2V DC	
Output 1	Relay: SPST max.250V AC, 5A (resistance load)	
	Transistor: NPN open collector. When 100mA /30V DC, residual voltage=1.5V DC max.	
Output 2	Relay: SPDT max.250V AC, 5A (resistance load)	
	Transistor: NPN open collector. When 100mA /30V DC, residual voltage=1.5V DC max.	
Dielectric strength	2,000V AC, 50/60 Hz for 1 minute	1,000V AC, 50/60Hz for 1 minute

Vibration resistance	Without damage: 10 ~ 55Hz, amplitude=0.75mm, 3 axes for 2 hours
Shock resistance	Without damage: drop 4 times, 300m/s ² , 3 edges, 6 surfaces and 1 corner
Ambient temperature	0 ~ 50°C
Storage temperature	-20 ~ +65°C
Altitude	2,000m or less
Ambient humidity	35 ~ 85% RH (non-condensing)
Pollution degree	Degree 2

■ Parameters in Configuration Mode

◆ Timer

FUnC Select a function MODE →	t mode Setup Timer function, (counting up or down) MODE →	t outnd Select output mode of Timer MODE →	t Unit Setup the displayed unit of timer MODE →	t out1 Setup the pulse width of output 1 MODE →	rtSr Reset min. pulse width MODE →	inpTLC Select input type (PNP or NPN) MODE →	Back to "select a function"
--	--	---	--	--	---	---	-----------------------------

◆ Counter

FUnC Select a function MODE →	cntFUN Select counting modes MODE →	inpTLC Setup input mode of Counter MODE →	t outnd Setup output mode of Counter (not dual output) MODE →	dUAL Setup dual output counting mode (dual output) MODE →	SPED Setup counting speed MODE →	t out1 Setup the pulse width of output 1 MODE ↓	
Back to "select a function"	inpTLC Select input type (PNP or NPN) ← MODE	rtSr Reset min. pulse width ← MODE	PuERS Save data or not while switching off power ← MODE	PSCALE Setup pre-scale value ← MODE	PoCnt Setup the decimal point ← MODE	t out2 Setup the pulse width of output 2 ← MODE	

◆ Tachometer

FUnC Select a function MODE →	tAotnd Setup output mode of Tachometer MODE →	SPED Setup counting speed MODE →	PoCnt Setup the decimal point MODE →	PSCALE Setup pre-scale value MODE ↓	
Back to "select a function"	inpTLC Select input type (PNP or NPN) ← MODE	rtSr Reset min. pulse width ← MODE	StAVE Setup the average of input data ← MODE	SttAC Setup the delay time while switching on power ← MODE	

◆ Timer + Counter

FUnC Select a function MODE →	t mode Setup Timer function, (counting up or down) MODE →	t outnd Setup output mode of timer MODE →	t Unit Setup the displayed unit of timer MODE →	inpTLC Setup input mode of Counter MODE →	t outnd Setup output mode of Counter (not dual output) MODE →	SPED Setup counting speed MODE →	t out1 Setup the pulse width of output 1 MODE ↓
Back to "select a function"	inpTLC Select input type (PNP or NPN) ← MODE	rtSr Reset min. pulse width ← MODE	PuERS Save data or not while switching off power ← MODE	PSCALE Setup pre-scale value ← MODE	PoCnt Setup the decimal point ← MODE	t out2 Setup the pulse width of output 2 ← MODE	

◆ Communication

CoMS Enable/ Disable write function MODE →	C-SL ASCII /RTU format selection MODE →	C-no Address setting MODE →	bPS Baud rate setting MODE →	LEn Date length setting MODE →	Prty Parity bit setting MODE →	StoP Stop bit setting MODE →	Back to "select a function"
--	---	---	--	--	--	--	-----------------------------------

◆ Open Communication parameter method:

1) Press "LOCK" key first, CTA will be in the lock status.

2) Press at the same time over 2 seconds, CTA will go to the special mode. Display **PASS** and **CtAxx0**.

3) When PV display **PASS**, Press keys, adjusting value to **4323** and press key to confirm.

4) Restart the power on, we can see the communication setting parameters in the "setting mode".

5) If CTA in lock status, we can press and Keys as the same time to release lock status.

■ Timer Function

There are counting up/down modes, several counting units and output modes to choose from in timer function.

t mode: Select counting up **UP** or counting down **down**

t out t: Setup the output time of timer, from 0 to 99.99 secs. 0= Hold output

t out d: Setup output modes

t unit t: Setup the counting unit of the timer.

5 00 1	sec	0.01 ~ 9,999.99	A unit = 10ms.	Max. counting = 9,999.99 secs.
5 0 1	sec	0.1 ~ 99,999.9	A unit = 0.1sec.	Max. counting = 99,999.9 secs.
5 1	sec	1 ~ 999,999	A unit = 1 sec.	Max. counting = 999,999 secs.
5 00 1	min, sec	0.01 ~ 9,959.99	A unit = 0.01 sec.	Max. counting = 5,999.99 secs.
5 0 1	min, sec	0.1 ~ 99,959.9	A unit = 0.1 sec.	Max. counting = 59,999.9 secs.
5 0 1	min	0.1 ~ 99,999.9	A unit = 0.1 min.	Max. counting = 99,999.9 mins.
5 1	min	1 ~ 999,999	A unit = 1 min.	Max. counting = 999,999 mins.
5 5 1	hr, min, sec	1 ~ 995,959	A unit = 1 sec.	Max. counting = 359,999 secs (100hr)
5 5 1	hr, min	1 ~ 999,959	A unit = 1 min.	Max. counting = 35,999,999 secs (10,000hr)
5 1	hr	1 ~ 999,999	A unit = 1 hr.	Max. counting = 999,999 hrs

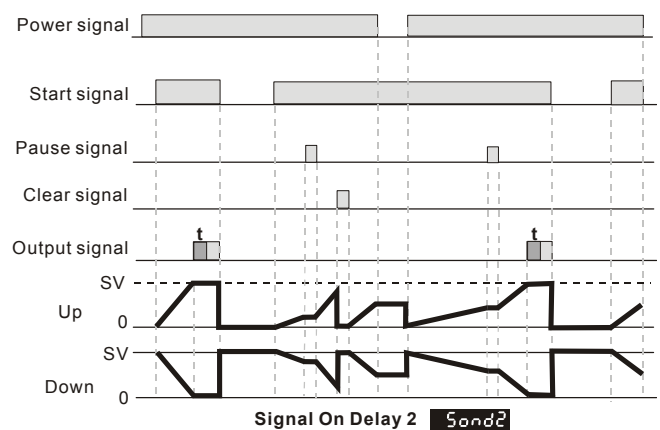
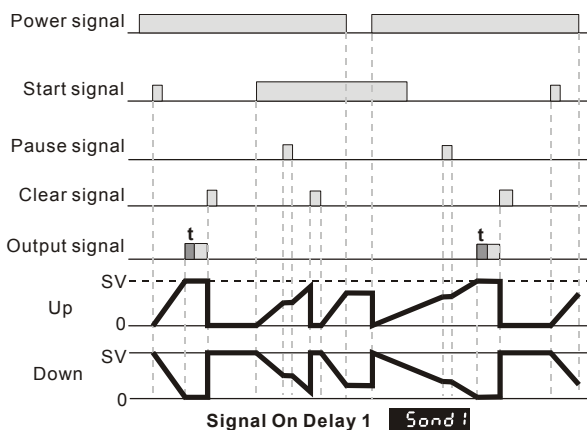

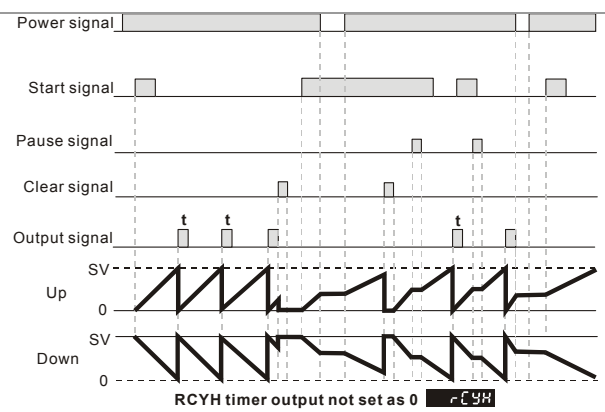
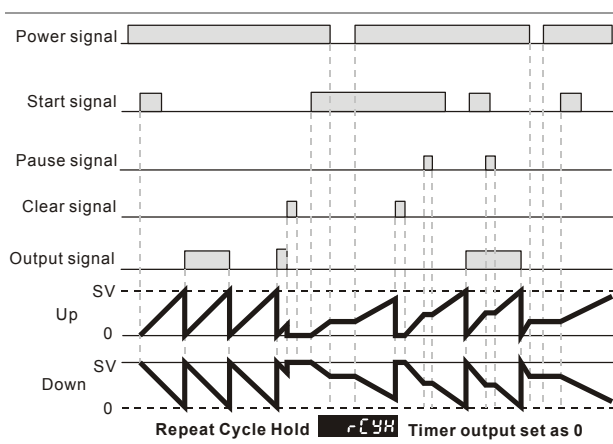
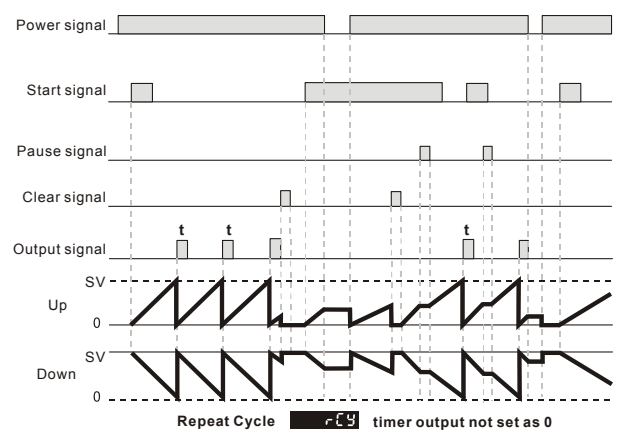
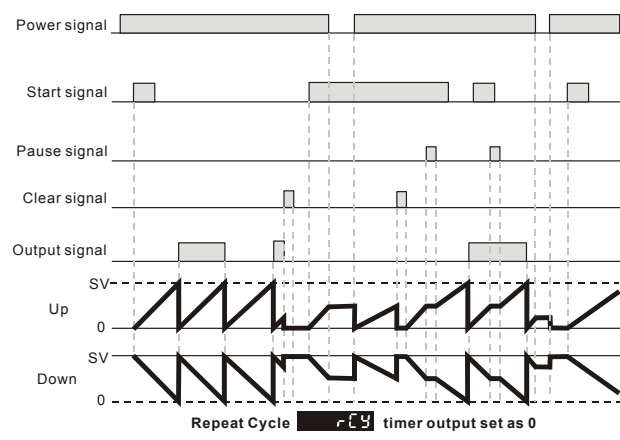
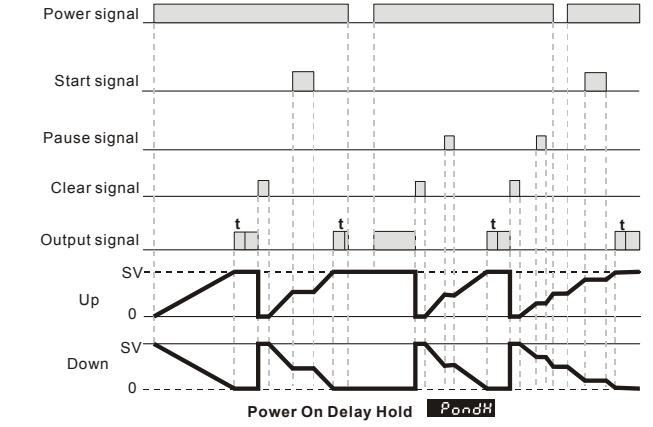
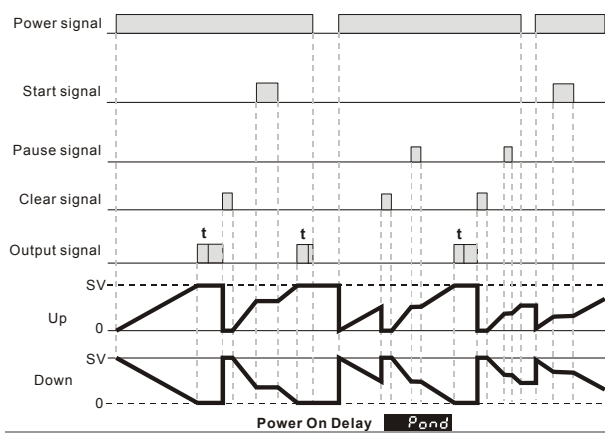
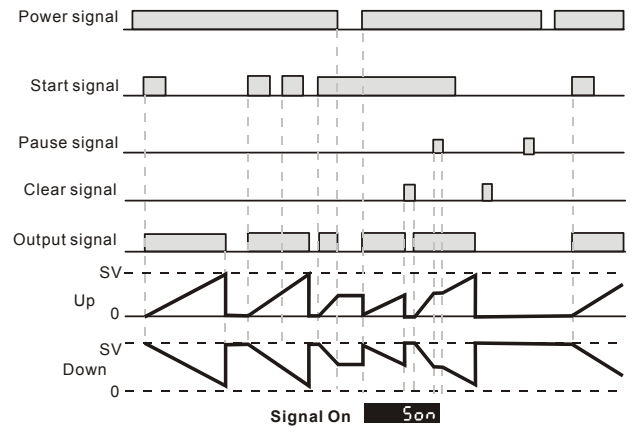
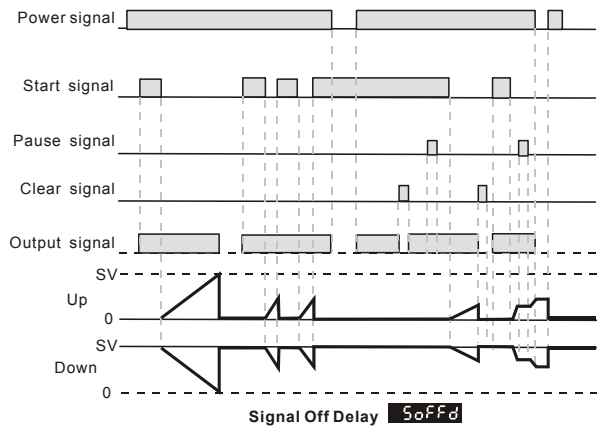

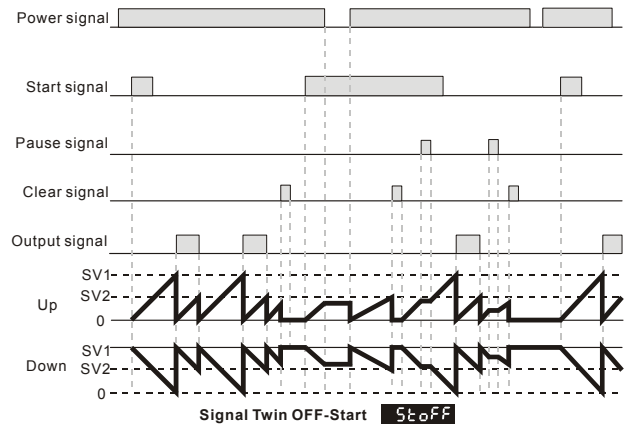
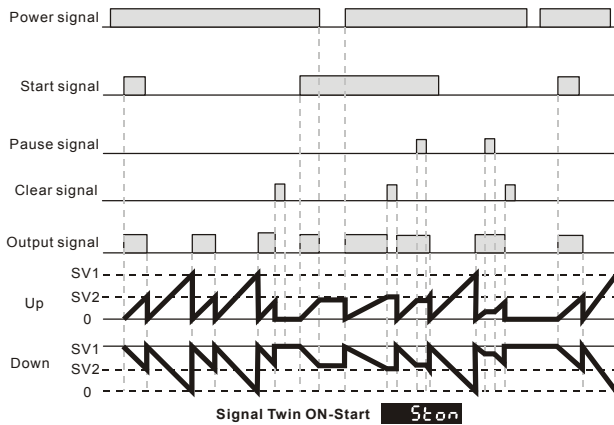
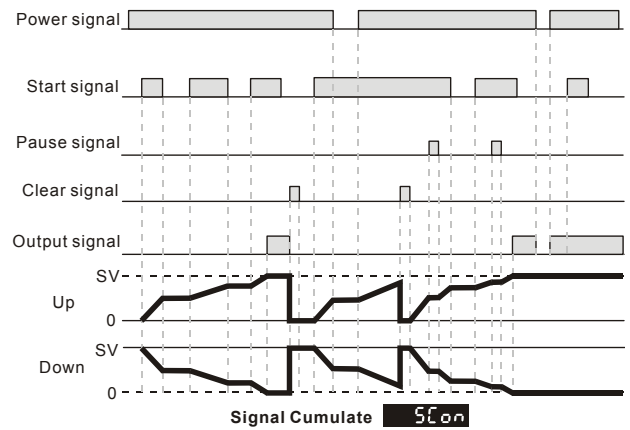
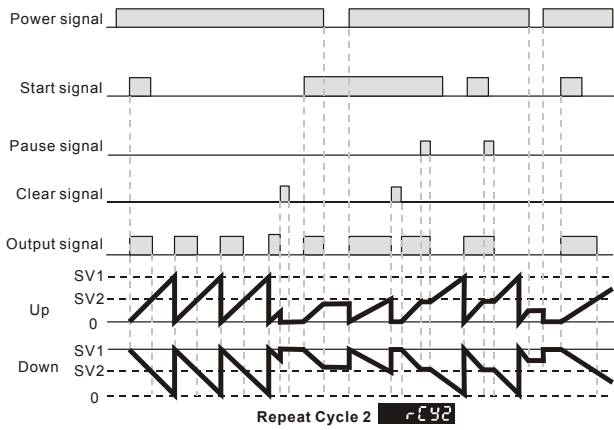

■ Counter Function

Counter functions include 1-stage counting, 2-stage counting, batch counting, total counting and dual counting.

STAGE1	1-stage	Only 1 SV is allowed. See "output modes of counter".
STAGE2	2-stage	2 SVs, 2 PVs are allowed. See "output modes of counter".
BATCH	Batch	Apart from the counting of PV and SV, when PV=SV, the batch counting adds 1 and clear PV as 0 for recounting till the batch counting equals batch SV.
TOTAL	Total	Total counting adds up all the counting values till they reach SV for output.
DUAL	Dual	CP1 and CP2 can be independent counters, but the counting speed can only reach 5kHz. CP1 and CP2 can execute addition Add or subtraction Sub .

Input modes of counter **[C] CAPt**

UP	Counting up	Ud b	Individual
down	Counting down	Ud c	Quadrature
Ud A	Command		

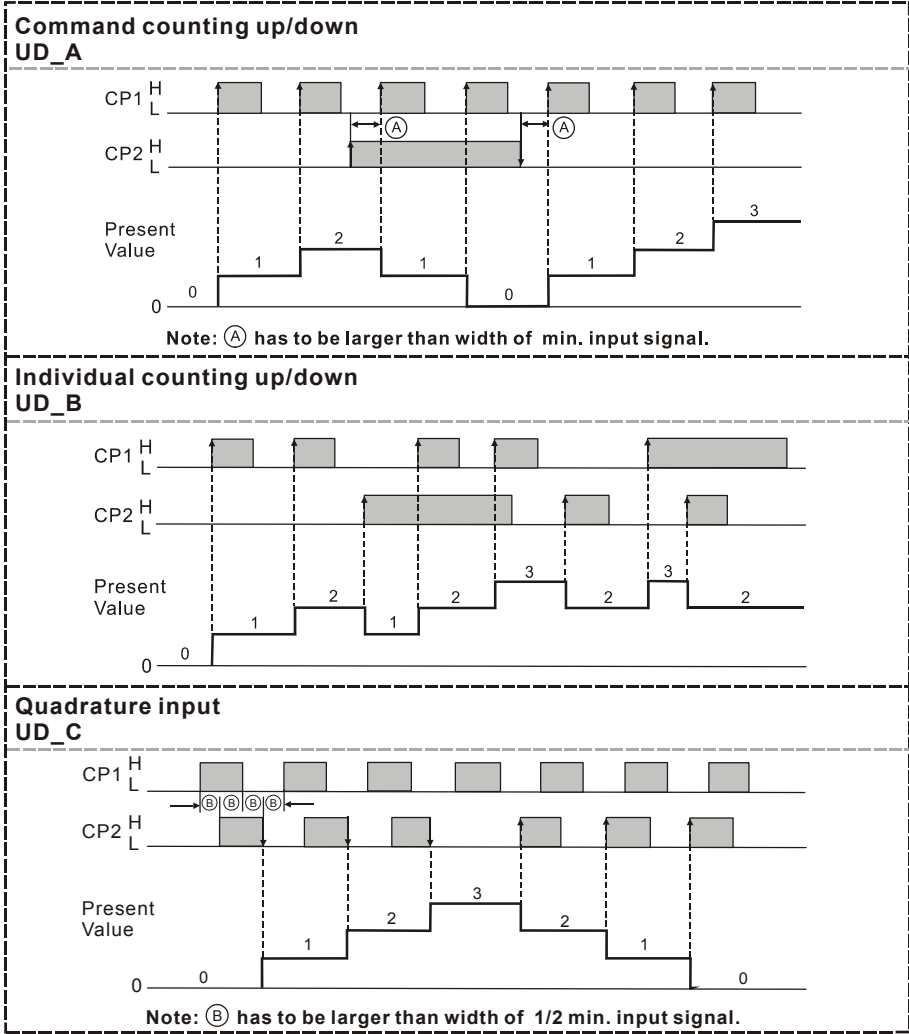
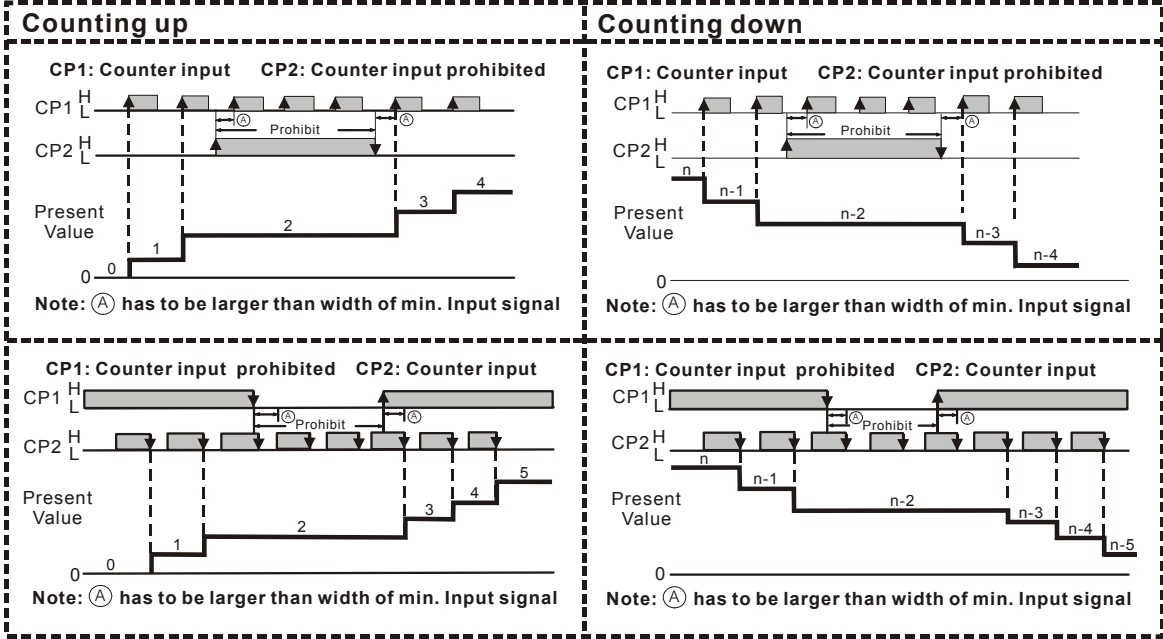

Output modes of counter [obnd] :

The output of SV can be 1-stage or 2-stage. When the output is set as 1-stage, Output 2 will be the same as the Output 1. The output modes include: F, N, C, R, K, P, Q, A, S, T, D

F	F	When PV reaches SV, output is enabled but counting continues. Recounting starts after reset signal is over. Output 2 remains.
N	N	When PV reaches SV, output is enabled but counting stops. Recounting starts after reset signal is over. Output 2 remains.
C	C	When PV reaches SV, recounting executes automatically. Output 2 is pulse output. Output 1 remains till Output 2 is over.
R	R	When PV reaches SV, counting stops till Output 2 (pulse) is over for recounting. Output 1 remains till Output 2 is over.
K	K	When PV reaches SV, output is enabled but counting continues. Recounting starts after reset signal is over.
P	P	When PV reaches SV, output is enabled and recounting is automatically executed. But display of counting remains till Output 2 (pulse) is over.
Q	Q	When PV reaches SV, output is enabled but the counting continues. Recounting starts after Output 2 (pulse) is over.
A	A	When PV reaches SV, output is enabled but the counting stops. Recounting starts and Output 2 (pulse) executes after reset signal is over.
S	S	When $PV \geq SV1$, Output 1 is enabled. When $PV \geq SV2$, Output 2 is enabled
T	T	When $PV \leq SV1$, Output 1 is enabled. When $PV \geq SV2$, Output 2 is enabled.
d	D	When $SV=PV$, output is enabled but counting continues. Addition and subtraction modes are valid.

The time of Output 1 and Output 2 (pulse) can be setup separately, ranging from 0.01 to 99.99 secs. Recounting refers to counting up or addition/subtraction counting starting from 0 and counting down starting from SV. The counting range: -99999~999999. The counting will restart from 0 if the counting exceeds the range.

		Input mode		
		Up	Down	Up/Down A, B, C
Output mode setting	F			
	N			
	C			
	R			

		Input mode		
		Up	Down	Up/Down A, B, C
Output mode setting	K			
	P			
	Q			
	A			

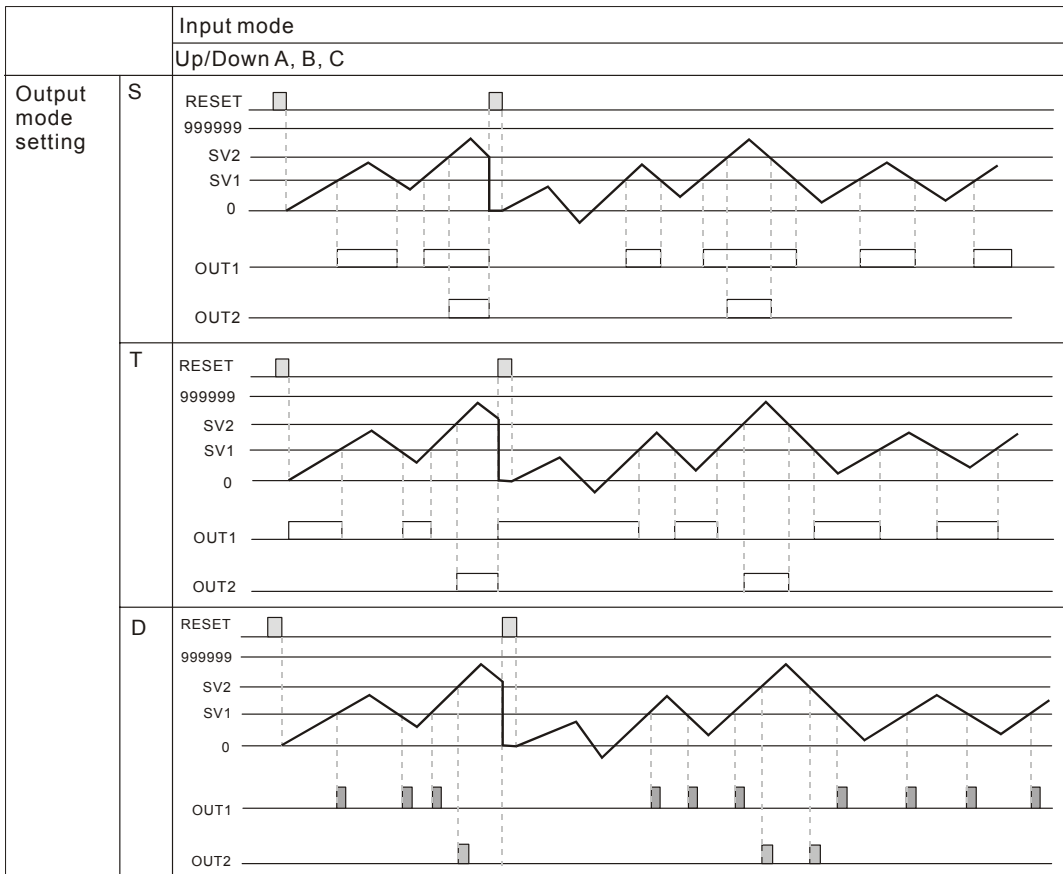

Save the data before power off **PUERS**: When **SRUS** is set, the current PV will be saved. When **CLEAR** is displayed, the PV will be cleared.

Pre-scale function **PSCALE**: When conducting unit conversion, $PV = PV \times \text{PreScale value}$, ranging from 0.001 to 99.999.

■ RS-485 Communication

1. Wiring Terminals: Terminal 9: RS-485+, Terminal 14: RS-485-
2. Serial Data Format: Supported transmission speed: 2,400, 4,800, 9,600, 19,200, 38,400bps; Not supported formats: 7,N,1 or 8,O,2 or 8,E,2
3. Communication Protocol: Supported Modbus ASCII/RTU mode; Function codes: 03H register read and 06H single register write; Function code 03H can read maximum 8 words at a time

ASCII Mode

Register Read (03H)		Response		Register Write (06H)		Response	
Start character	' : '	Start character	' : '	Start character	' : '	Start character	' : '
Address	'0'	Address	'0'	Address	'0'	Address	'0'
	'1'		'1'		'1'		'1'
Function code	'0'	Function code	'0'	Function code	'0'	Function code	'0'
	'3'		'3'		'6'		'6'
Start address of read data	'1'	Data length (byte)	'0'	Data address	'1'	Data address	'1'
	'0'		'4'		'0'		'0'
	'0'	Address 1000H	'0'		'0'		'0'
	'0'		'1'		'1'		
Word length	'0'	Data content	'F'	Data content	'0'	Data content	'0'
	'0'		'4'		'3'		'3'
	'0'	Address 1001H	'0'		'E'		'E'
	'2'		'0'		'8'		'8'
LRC Checksum	'E'		'0'	LRC Checksum	'F'	LRC Checksum	'F'

	'A'		'0'		'D'		'D'
End character	CR	LRC Checksum	'0'	End character	CR	End character	CR
	LF		'3'		LF		LF
		End character	CR				
			LF				

*CR = 10H, LF = 0AH

LRC Checksum = 2's complement of (Address + Function code + Hi byte of start address + ...)

For example: 01H + 03H + 10+ 00H + 00H + 02H = 16H, and LRC = 2's complement of 16H = EAH

RTU Mode

Register Read (03H)		Response		Register Write (06H)		Response	
Address	01H	Address	01H	Address	01H	Address	01H
Function code	03H	Function code	03H	Function code	06H	Function code	06H
Start address of read data	10H	Data length (byte)	04H	Data address	10H	Data address	10H
	00H				01H		01H
Word length)	00H	Address 1000H	01H	Data content	03H	Data content	03H
	02H	Data content	F4H		20H		20H
CRC Low byte	C0H	Address 1001H	03H	CRC Low byte	DDH	CRC Low byte	DDH
CRC high byte	CBH	Data content	20H	CRC high byte	E2H	CRC high byte	E2H
		CRC Low byte	BBH				
		CRC high byte	15H				

CRC Program Example:

```

unsigned int reg_crc = 0xffff;
i = 0; while (length--)
{ reg_crc ^= RTUData[i]; i++;
  for (j = 0; j < 8; j++)
  { if (reg_crc & 0x01) reg_crc = (reg_crc >> 1) ^ 0xA001;
    else reg_crc = reg_crc >> 1; } }
return(reg_crc);

```

4. Address & Data Register Content

Address	Default	Timer	Counter	Tachometer	Content	Remark
1000H	0	V	V	V	PV1 (Low byte)	
1001H	0	V	V	V	PV1 (High byte)	
1002H	0		V		PV2 (Low byte)	Available on batch, total, dual counter and mixed mode
1003H	0		V		PV2 (High byte)	
1004H	0	V	V	V	SV1 (Low byte)	
1005H	0	V	V	V	SV1 (High byte)	Read/write low byte (1004H) in advance is required.
1006H	0	V	V	V	SV2 (Low byte)	
1007H	0	V	V	V	SV2 (High byte)	Read/write low byte (1006H) in advance is required.
1008H	0	V	V	V	Select function	0: Timer; 1: Counter; 2: Tachometer; 3: Mixed function
1009H	0		V		Counter function	0: 1-stage; 1: 2-stage; 2: Batch; 3: Total; 4: Dual
100AH	0	V	V	V	Input type	0: PNP; 1: NPN
100BH	0	V			Timer function	0: Counting up; 1: Counting down
100CH	0	V			Timer output mode	See Table 1 "Timer Output Mode"
100DH	0	V			Counting unit for timer	See Table 1 "Timer Display"
100EH	0		V		Input mode of counter	0: Counting up; 1: Counting down; 2: Command; 3: Individual; 4: Quadrature
100FH	0		V		Dual output counting mode	0: Sum; 1: Subtract
1010H	0		V		Counter output mode	See Table 1 "Counter Output Mode"
1011H	4		V	V	Counting speed	0: 1Hz; 1: 30Hz; 2: 200Hz; 3: 1kHz; 4: 5kHz; 5: 10kHz
1012H	2	V	V		Pulse width of output 1	Range: 0 ~ 9,999; Unit: 10ms, 0: Sustained mode

1013H	2	V	V		Pulse width of output 2	Range: 1 ~ 9,999; Unit: 10ms, 0: Sustained mode
1014H	0		V	V	Decimal position	0 ~ 3
1015H	1000		V	V	Pre-scale value	Range: 1 ~ 99,999; Unit: 0.001
1016H	0		V		Data save on loss power	0: No action; 1: Save present data
1017H	0	V	V	V	Reset min. pulse width	0: 20ms; 1: 1ms
1018H	0			V	Tachometer output mode	0: Lo-Lo; 1: Lo-Hi; 2: Hi-Lo; 3: Hi-Hi (Tachometer)
1019H	0			V	Delay time while power on	0 ~ 999; Unit: 0.1s
101AH	0			V	Average of input data	0 ~ 3
101BH	0	V	V	V	Front panel lock status	0: Normal; 1: Lock all; 2: SV can be set
101EH		V	V	V	Read version	Read only

Value	Timer Output Mode	Timer Display	Counter Output Mode	Value	Timer Output Mode	Timer Display	Counter Output Mode
0	Signal ON Delay1	0.01s	F	6	Repeat Cycle	1 min	Q
1	Signal ON Delay2	0.1s	N	7	Repeat Cycle Hold	hr, min, 1s	A
2	Signal OFF Delay	1s	C	8	Repeat Cycle 2	hr, 1min	S
3	Signal ON	min, 0.01s	R	9	Signal Cumulate	1hr	T
4	Power ON Delay	min, 0.1s	K	10	Signal Twin ON Start		D
5	Power ON Delay Hold	0.1 min	P	11	Signal Twin OFF Start		

Table 1

■ Tachometer Function

Measuring Rotation speed: Measuring pulse width and determining current frequency

Output methods: Lo-Lo, Lo-Hi, Hi-Lo, Hi-Hi

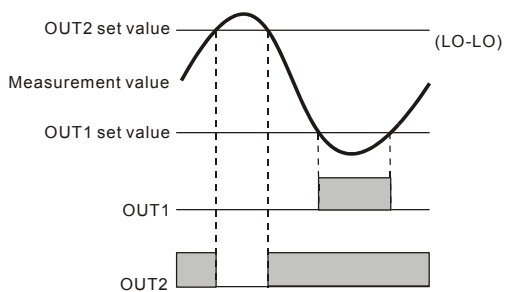

Measurement value \leq OUT1 set value : OUT1 ON
Measurement value \leq OUT2 set value : OUT2 ON

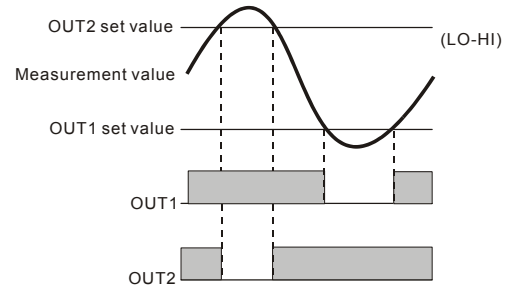

Measurement value \geq OUT1 set value : OUT1 ON
Measurement value \leq OUT2 set value : OUT2 ON

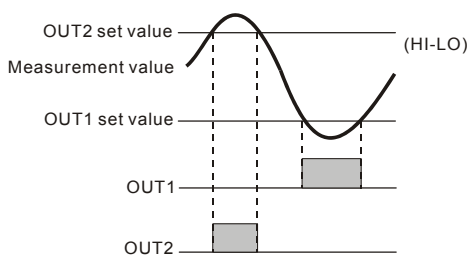

Measurement value \leq OUT1 set value : OUT1 ON
Measurement value \geq OUT2 set value : OUT2 ON

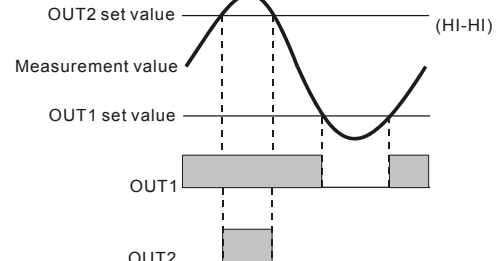

Measurement value \geq OUT1 set value : OUT1 ON
Measurement value \geq OUT2 set value : OUT2 ON

Delay time after switching on the power **SE EAC**: The tachometer will start to run when the set delay time is due after the power is switched on. (Range of delay time: 0.1 ~ 99.9 secs.)

Setup average value of input filter **SE A06**: Range for obtaining average (n = 0 ~ 3). This parameter obtains the average of 2^n input data for more stable output value.

■ Timer + Counter Function

In Timer + Counter function, SV1, PV1 and Output 1 are for Timer; SV2, PV2 and Output2 are for Counter. DIP switch is disabled. All timer and counter functions remain except

- RCY2, SCON, STON, STOFF in output mode of Timer function
- Command up/down, Individual up/down, quadrature counting in input mode, S, T, D in output mode of Counter function

Only 1-stage counting in Counter function is available.

■ Easy DIP Switch Setup

Users can use DIP switch to setup parameters. When DIP is switched to ON, the corresponding parameters can only be read, not changed.

SW	Counter	Timer	Tachometer
8	Reset pulse width ON: 1ms, OFF: 20ms	Reset pulse width ON: 1ms, OFF: 20ms	Reset pulse width ON: 1ms, OFF: 20ms
7	Input type ON: PNP OFF: NPN	Unit of Timer See Table 2	Input type ON: PNP OFF: NPN
6	N/A	Unit of Timer See Table 2	N/A
5	Counting speed ON: 10KCPS OFF: 30CPS	Unit of Timer See Table 2	Counting speed ON: 10kHz OFF: 30Hz
4	Output mode of counter See Table 3	Output mode of Timer See Table 3	Output mode of Tachometer See Table 3
3	Output mode of counter See Table 3	Output mode of Timer See Table 3	Output mode of Tachometer See Table 3
2	Input mode of counter ON: counting down OFF: counting up	Time counting up/down ON: down OFF: up	N/A
1	ON: Enable DIP OFF: Disable DIP	ON: Enable DIP OFF: Disable DIP	ON: Enable DIP OFF: Disable DIP

SW5	SW6	SW7	Displayed unit
OFF	OFF	OFF	0.01s
ON	OFF	OFF	0.1s
OFF	ON	OFF	1s
ON	ON	OFF	min, 0.01s
OFF	OFF	ON	min, 0.1s
ON	OFF	ON	0.1 min
OFF	ON	ON	min
ON	ON	ON	hr, min, sec

Table 2

Table 3

SW3	SW4	Output Mode Configuration		
		Counter	Timer	Tachometer
OFF	OFF	F	Signal ON Delay 1	Lo-Lo
ON	OFF	N	Signal ON Delay 2	Lo-Hi
OFF	ON	C	Signal OFF Delay	Hi-Lo
ON	ON	R	Signal ON	Hi-Hi

Terminal Definition

Input connections:

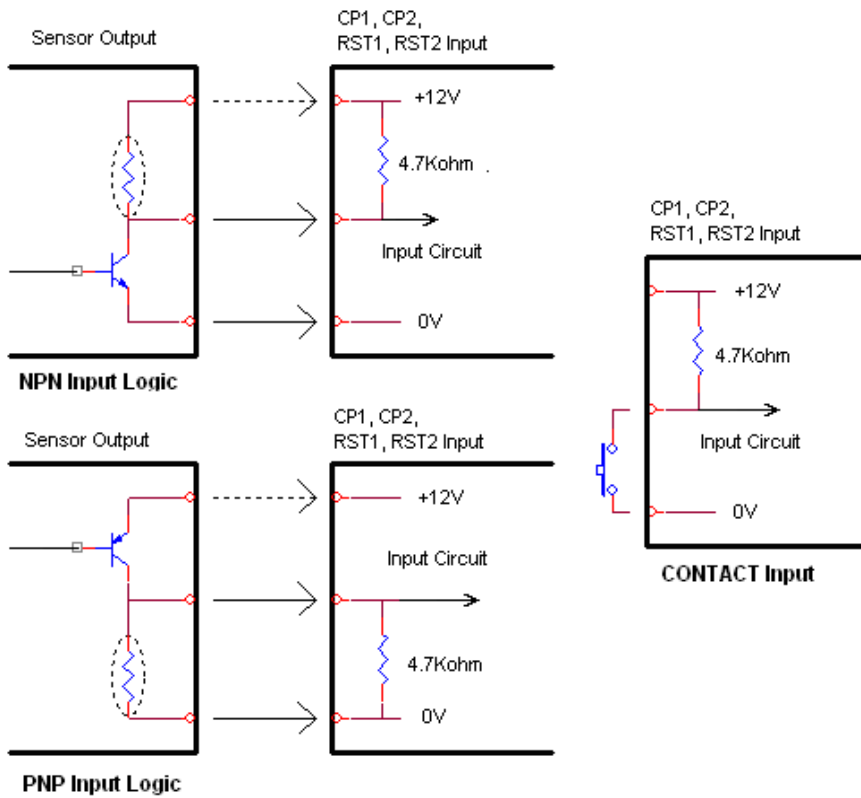

CTA4000A/4100A series:

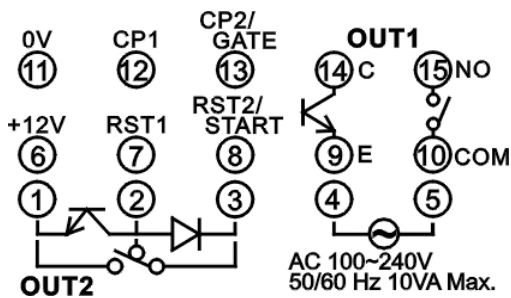

CTA4001A/4101A series:

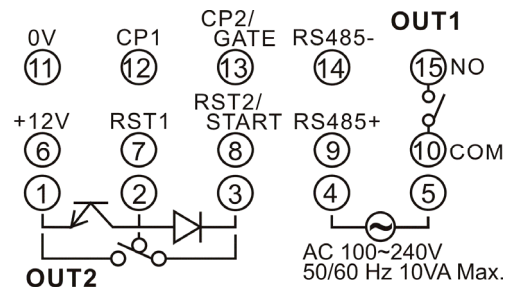

CTA4000D/4100D series:

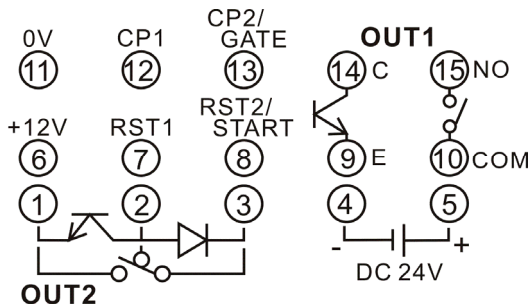

CTA4001D/4101D series:

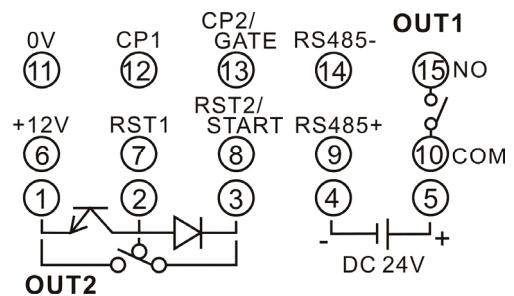

Multi-function input pin:

Counter	Timer	Tachometer	Timer + Counter
CP1		CP1	CP1
CP2	Gate		Gate
Reset1	Reset1	Reset1	Reset1
Reset2	Start		Start

■ Dimension & Panel Cutout

CTA4 series

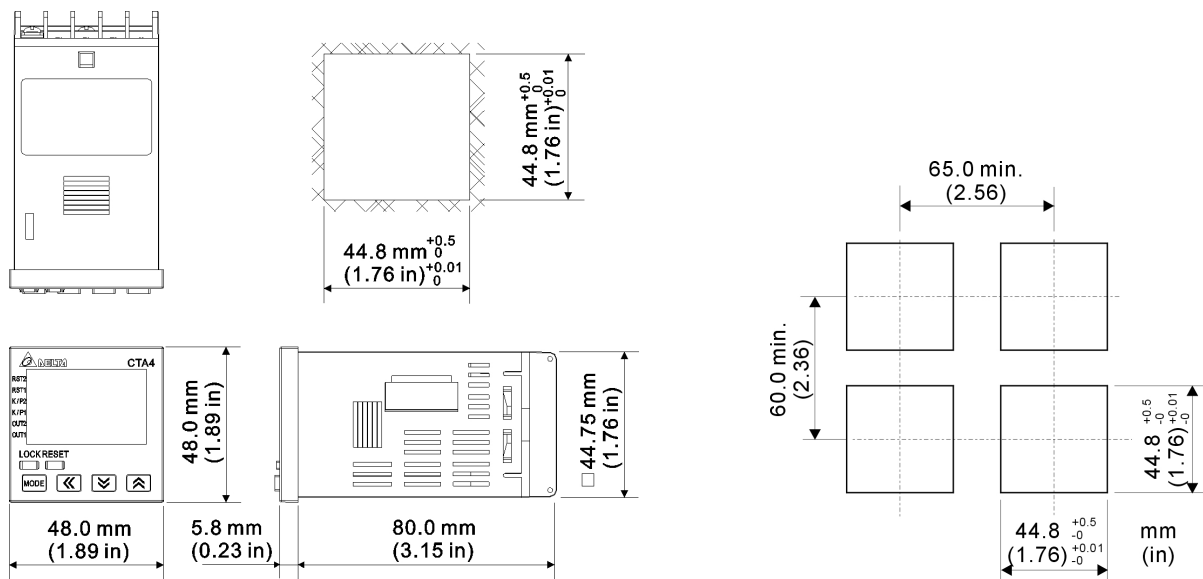

■ How to Mount

1. Insert the controller through the panel cutout.
2. Insert the mounting bracket into the mounting groove at the top and bottom of the controller and push the mounting bracket forward until the bracket stops at panel wall.
3. Insert and tighten screws on bracket to secure the controller in place.

